

INN700TK240C

1. General description

700V GaN-on-Silicon Enhancement-mode Power Transistor in TO-252 package.

2. Features

- Enhancement mode transistor-Normally off power switch
- Ultra high switching frequency
- No reverse-recovery charge
- Low gate charge, low output charge
- Qualified for industrial applications according to JEDEC Standards
- ESD safeguard
- RoHS, Pb-free, REACH-compliant

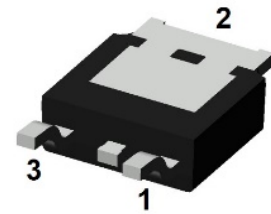
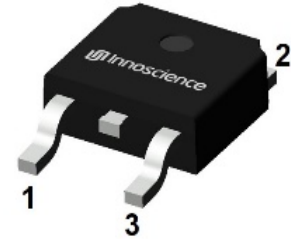

3. Applications

- AC-DC converters
- DC-DC converters
- Totem pole PFC
- Fast battery charging
- High density power conversion
- High efficiency power conversion

4. Key performance parameters

Table 1 Key performance parameters at $T_j = 25\text{ }^\circ\text{C}$

Parameter	Value	Unit
$V_{DS,max}$	700	V
$R_{DS(on),max}$ @ $V_{GS} = 6\text{ V}$	240	m Ω
$Q_{G,typ}$ @ $V_{DS} = 400\text{ V}$	2	nC
$I_{D,pulse}$	18	A
Q_{OSS} @ $V_{DS} = 400\text{ V}$	21	nC
Q_{rr} @ $V_{DS} = 400\text{ V}$	0	nC

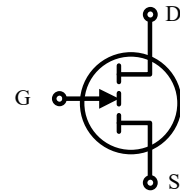

5. Pin information

Table 2 Pin information

Gate	Source	Drain
1	2	3

Table 3 Ordering information

Type/Ordering Code	Package	Product Code
INN700TK240C	TO-252	70TK240C

Table of contents

1. General description	1
2. Features	1
3. Applications.....	1
4. Key performance parameters.....	1
5. Pin information	1
6. Maximum ratings.....	3
7. Thermal characteristics.....	4
8. Electric characteristics	5
9. Electric characteristics diagrams	7
10.Package outlines	13
11.Recommended PCB footprint	15
12.Revision history	16

6. Maximum ratings

at $T_j = 25\text{ °C}$ unless otherwise specified.

Exceeding the maximum ratings may destroy the device. For further information, contact Innoscence sales office.

Table 4 Maximum ratings

Parameter	Symbol	Values	Unit	Note/Test Condition
Drain source voltage	$V_{DS, max}$	700	V	$V_{GS} = 0\text{ V}$; $T_j = -55\text{ °C}$ to 150 °C
Drain source voltage transient ¹	$V_{DS, transient}$	800	V	$V_{GS} = 0\text{ V}$
Drain source voltage, pulsed ²	$V_{DS, pulse}$	750	V	$T_j = 25\text{ °C}$; total time < 10 h
				$T_j = 125\text{ °C}$; total time < 1 h
Continuous current, drain source	I_D	10	A	$T_c = 25\text{ °C}$
Pulsed current, drain source ³	$I_{D, pulse}$	18	A	$T_c = 25\text{ °C}$; $V_{GS} = 6\text{ V}$; $t_{PULSE} = 10\text{ }\mu\text{s}$
Pulsed current, drain source ³	$I_{D, pulse}$	10	A	$T_c = 125\text{ °C}$; $V_{GS} = 6\text{ V}$; $t_{PULSE} = 10\text{ }\mu\text{s}$
Gate source voltage, continuous	V_{GS}	-6 to +7	V	$T_j = -55\text{ °C}$ to 150 °C
Gate source voltage, pulsed	$V_{GS, pulse}$	-20 to +10	V	$T_j = -55\text{ °C}$ to 150 °C ; $t_{PULSE} = 50\text{ ns}$, $f = 100\text{ kHz}$; open drain
Power dissipation	P_{tot}	77	W	$T_c = 25\text{ °C}$
Operating temperature	T_j	-55 to +150	°C	
Storage temperature	T_{stg}	-55 to +150	°C	

1. $V_{DS, transient}$ is intended for non-repetitive events, $t_{PULSE} < 200\text{ }\mu\text{s}$.

2. $V_{DS, pulse}$ is intended for repetitive pulse, $t_{PULSE} < 100\text{ ns}$.

3. Limit was extracted from characterization test, not measured during production.

7. Thermal characteristics

Table 5 Thermal characteristics

Parameter	Symbol	Values	Unit	Note/Test Condition
Thermal resistance, junction-ambient	R_{thJA}^1	55	°C/W	
Thermal resistance, junction-case	R_{thJC}	1.62	°C/W	
Maximum reflow soldering temperature	T_{sold}	260	°C	MSL3

1. R_{thJA} is determined with the device mounted on one square inch of copper pad, single layer 2oz copper on FR4 board.

8. Electric characteristics

at $T_j = 25\text{ °C}$, unless specified otherwise

Table 6 Static characteristics

Parameter	Symbol	Values			Unit	Note/Test Condition
		Min.	Typ.	Max.		
Gate threshold voltage	$V_{GS(th)}$	1.2	1.7	2.5	V	$I_D = 11\text{ mA}; V_{DS} = V_{GS}; T_j = 25\text{ °C}$
		-	1.7	-		$I_D = 11\text{ mA}; V_{DS} = V_{GS}; T_j = 150\text{ °C}$
Drain-source leakage current	I_{DSS}	-	0.4	20	μA	$V_{DS} = 700\text{ V}; V_{GS} = 0\text{ V}; T_j = 25\text{ °C}$
		-	5	-		$V_{DS} = 700\text{ V}; V_{GS} = 0\text{ V}; T_j = 150\text{ °C}$
Gate-source leakage current	I_{GSS}	-	50	-	μA	$V_{GS} = 6\text{ V}; V_{DS} = 0\text{ V}$
Drain-source on-state resistance	$R_{DS(on)}$	-	165	240	m Ω	$V_{GS} = 6\text{ V}; I_D = 3\text{ A}; T_j = 25\text{ °C}$
		-	360	-		$V_{GS} = 6\text{ V}; I_D = 3\text{ A}; T_j = 150\text{ °C}$
Gate resistance	R_G	-	6	-	Ω	$f = 5\text{ MHz}; \text{open drain}$

Table 7 Dynamic characteristics

Parameter	Symbol	Values			Unit	Note/Test Condition
		Min.	Typ.	Max.		
Input capacitance	C_{iss}	-	79	-	pF	$V_{GS} = 0\text{ V}; V_{DS} = 400\text{ V}; f = 100\text{ kHz}$
Output capacitance	C_{oss}	-	25	-	pF	$V_{GS} = 0\text{ V}; V_{DS} = 400\text{ V}; f = 100\text{ kHz}$
Reverse transfer capacitance	C_{rss}	-	0.2	-	pF	$V_{GS} = 0\text{ V}; V_{DS} = 400\text{ V}; f = 100\text{ kHz}$
Effective output capacitance, energy related ¹	$C_{o(er)}$	-	36	-	pF	$V_{GS} = 0\text{ V}; V_{DS} = 0\text{ to }400\text{ V}$
Effective output capacitance, time related ²	$C_{o(tr)}$	-	52	-	pF	$V_{GS} = 0\text{ V}; V_{DS} = 0\text{ to }400\text{ V}$
Output charge	Q_{oss}	-	21	-	nC	$V_{GS} = 0\text{ V}; V_{DS} = 0\text{ to }400\text{ V}$
Turn-on delay time	$t_{d(on)}$	-	2	-	ns	$V_{DS} = 400\text{ V}; I_D = 6\text{ A}; L = 318\text{ }\mu\text{H};$ $V_{GS} = 6\text{ V}; R_{on} = 10\text{ }\Omega; R_{off} = 2\text{ }\Omega;$ See Figure 22
Turn-off delay time	$t_{d(off)}$	-	4	-	ns	
Rise time	t_r	-	5	-	ns	
Fall time	t_f	-	6	-	ns	

1. $C_{o(er)}$ is the fixed capacitance that gives the same stored energy as C_{oss} while V_{DS} is rising from 0 to 400 V.

2. $C_{o(tr)}$ is the fixed capacitance that gives the same charging time as C_{oss} while V_{DS} is rising from 0 to 400 V.

Table 8 Gate charge characteristics

Parameter	Symbol	Values			Unit	Note/Test Condition
		Min.	Typ.	Max.		
Gate charge	Q_G	-	2	-	nC	$V_{GS} = 0$ to 6 V; $V_{DS} = 400$ V; $I_D = 3$ A
Gate-source charge	Q_{GS}	-	0.2	-	nC	
Gate-drain charge	Q_{GD}	-	0.7	-	nC	
Gate Plateau Voltage	V_{Plat}	-	2.5	-	V	$V_{DS} = 400$ V; $I_D = 3$ A

Table 9 Reverse conduction characteristics

Parameter	Symbol	Values			Unit	Note/Test Condition
		Min.	Typ.	Max.		
Source-Drain reverse voltage	V_{SD}	-	2.6	-	V	$V_{GS} = 0$ V; $I_S = 3$ A
Pulsed current, reverse	$I_{S, pulse}$	-	-	18	A	$V_{GS} = 6$ V; $t_{PULSE} = 10$ μ s
Reverse recovery charge	Q_{rr}	-	0	-	nC	$I_S = 3$ A; $V_{DS} = 400$ V
Reverse recovery time	t_{rr}	-	0	-	ns	
Peak reverse recovery current	I_{rrm}	-	0	-	A	

9. Electric characteristics diagrams

at $T_j = 25\text{ }^\circ\text{C}$, unless specified otherwise

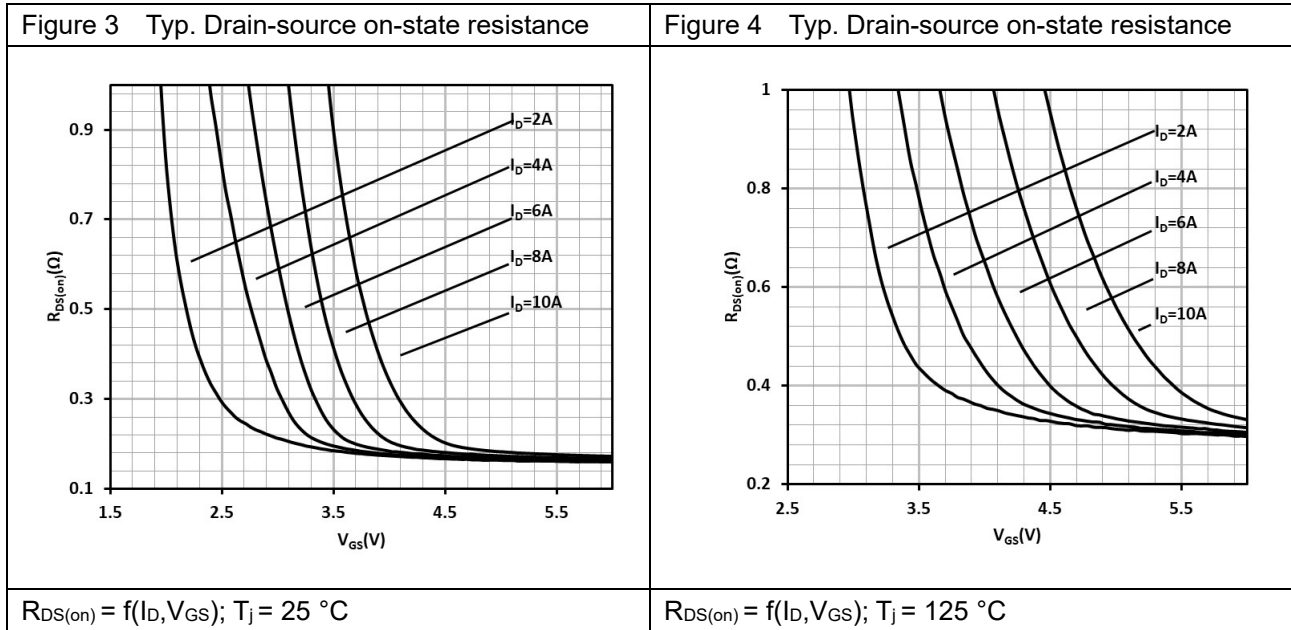
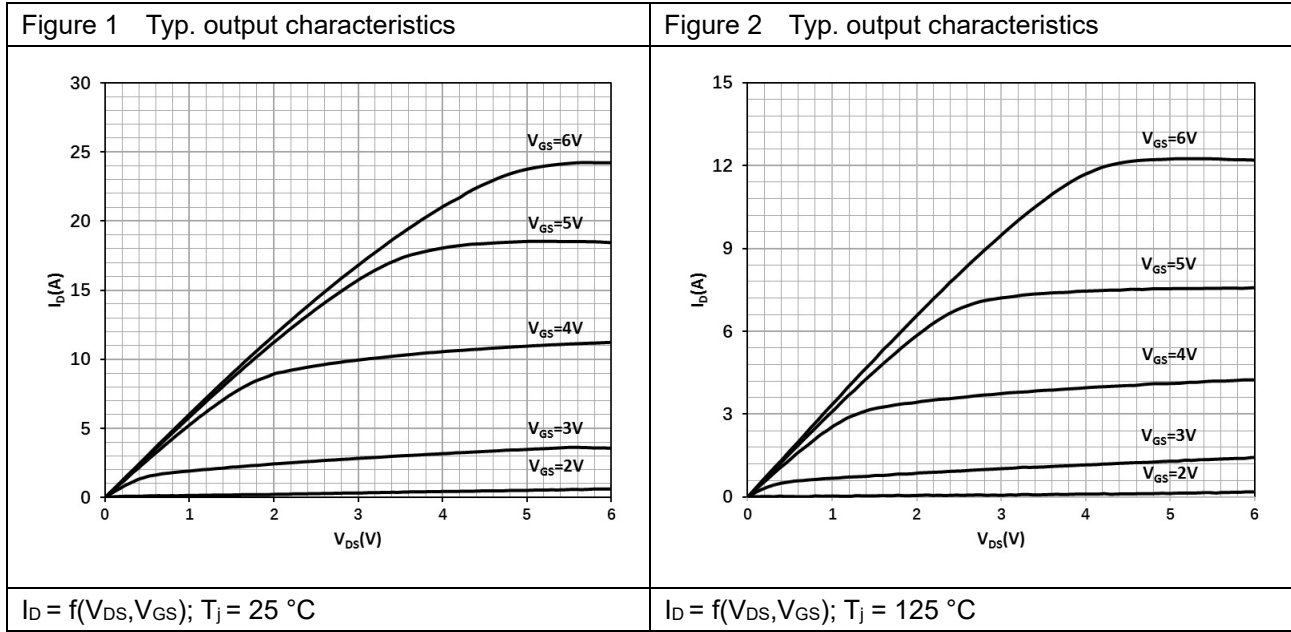
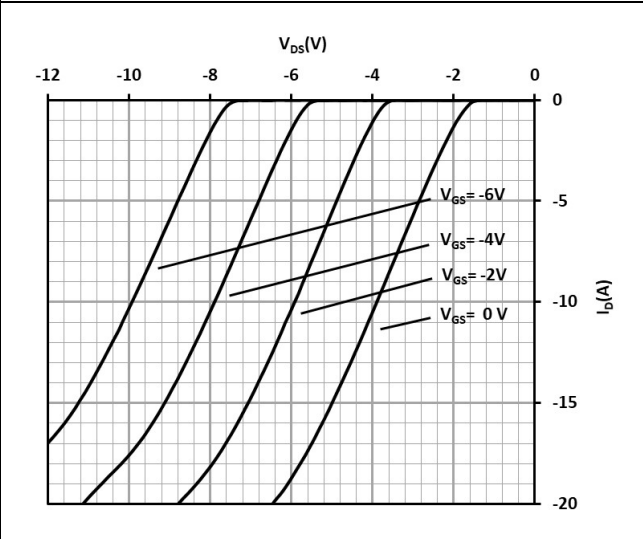
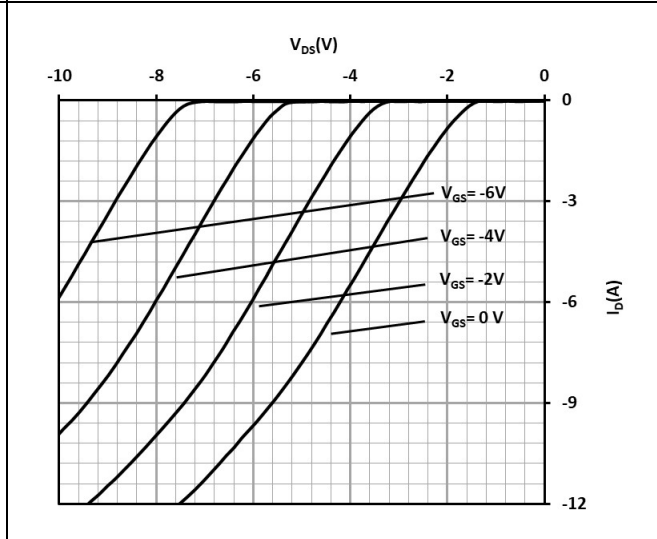

Figure 5 Typ. channel reverse characteristics



$I_D = f(V_{DS}, V_{GS}); T_j = 25\text{ °C}$

Figure 6 Typ. channel reverse characteristics



$I_D = f(V_{DS}, V_{GS}); T_j = 125\text{ °C}$

Figure 7 Typ. channel reverse characteristics

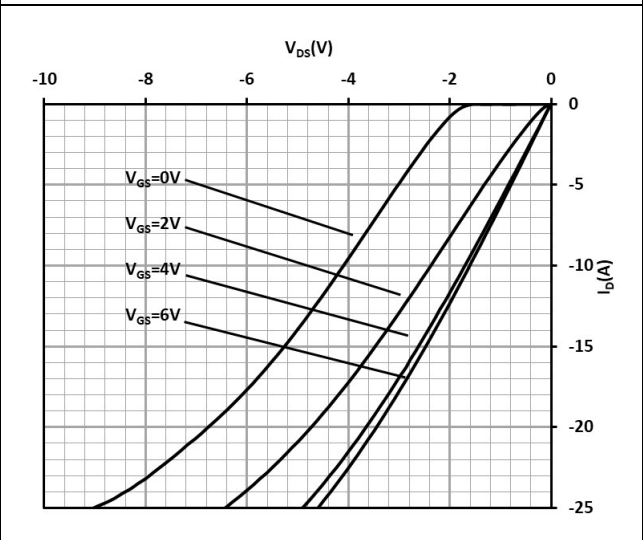

$I_D = f(V_{DS}, V_{GS}); T_j = 25\text{ °C}$

Figure 8 Typ. channel reverse characteristics

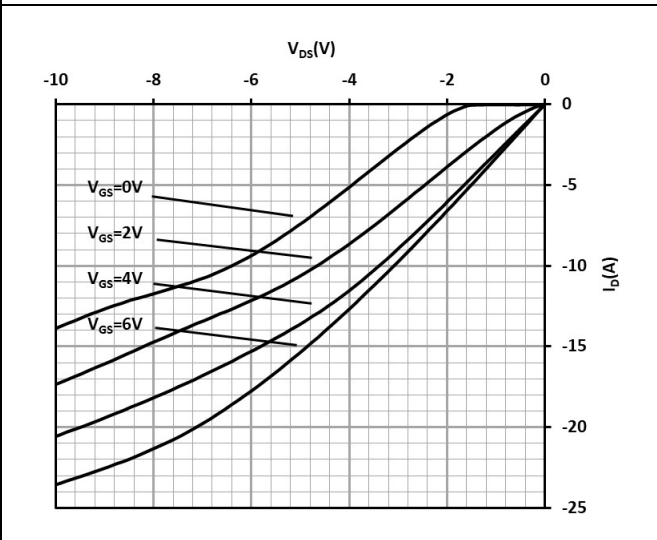

$I_D = f(V_{DS}, V_{GS}); T_j = 125\text{ °C}$

Figure 9 Typ. transfer characteristics

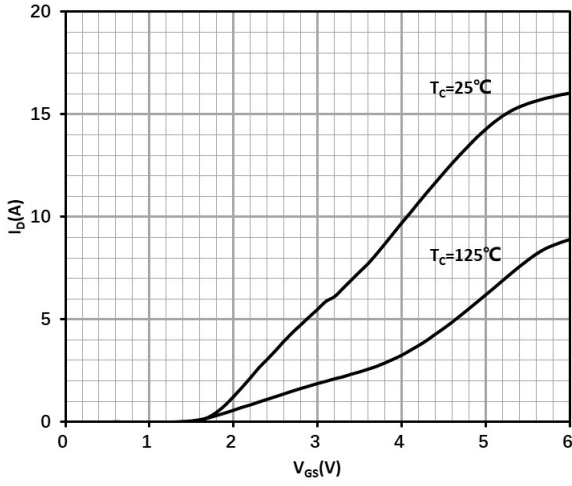

$I_D = f(V_{GS}); V_{DS} = 3\text{ V}$

Figure 10 Typ. Gate-to-Source leakage

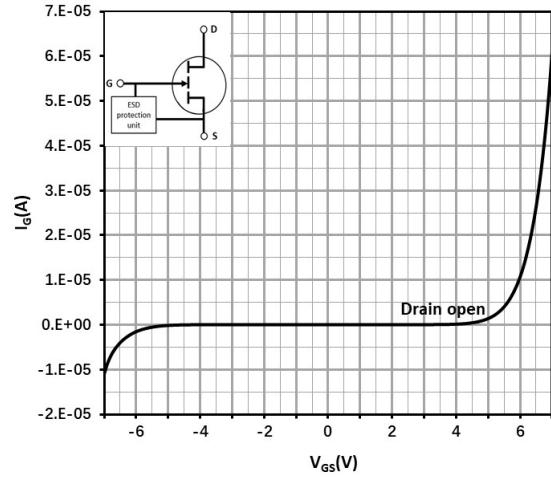

$I_G = f(V_{GS});$

Figure 11 Drain-source leakage characteristics

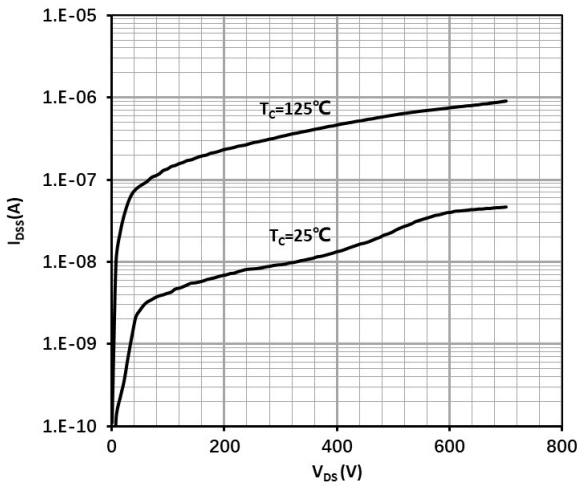

$I_{DSS} = f(V_{DS}); V_{GS} = 0\text{ V}$

Figure 12 Gate threshold voltage

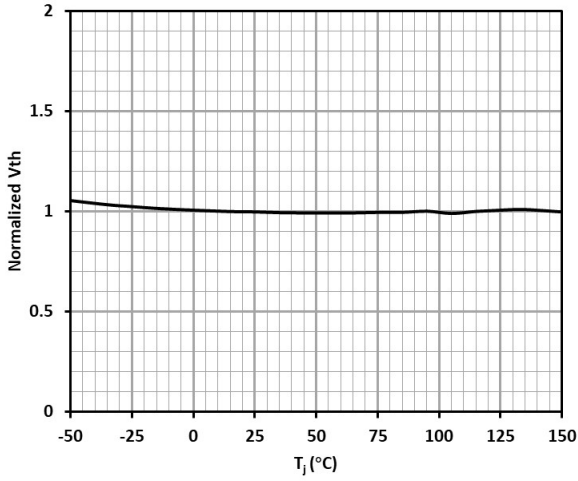

$V_{TH} = f(T_j); V_{GS} = V_{DS}; I_D = 11 \text{ mA}$

Figure 13 Drain-source on-state resistance

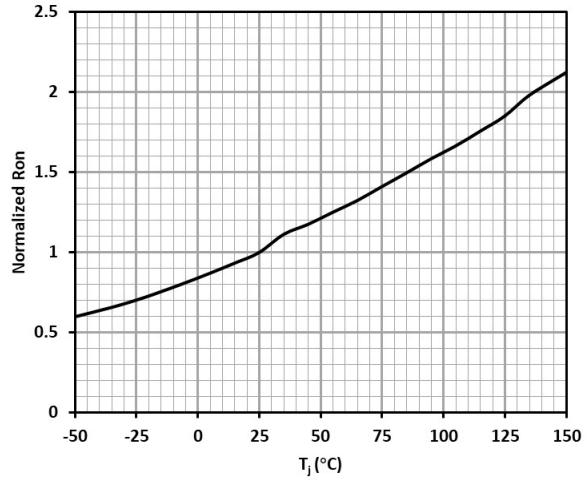

$R_{DS(on)} = f(T_j); I_D = 3 \text{ A}; V_{GS} = 6 \text{ V}$

Figure 14 Power dissipation

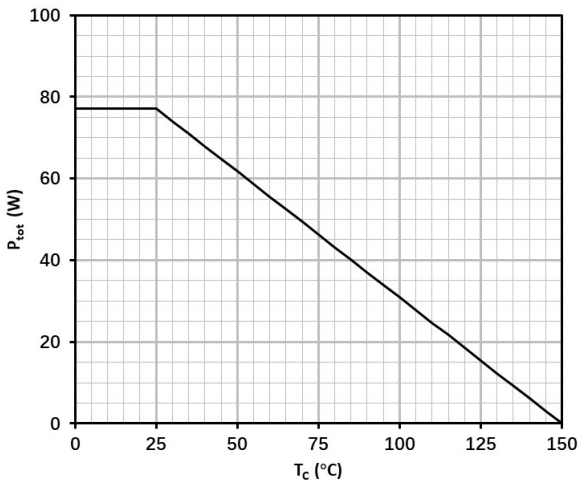

$P_{tot} = f(T_c)$

Figure 15 Max.transient thermal impedance

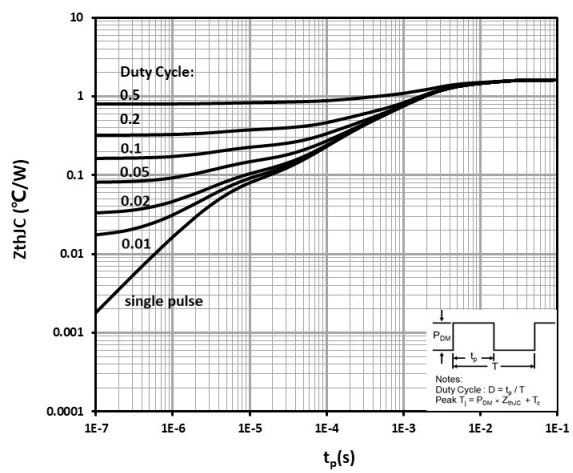

$Z_{thJC} = f(t_p, D)$

Figure 16 Safe operating area

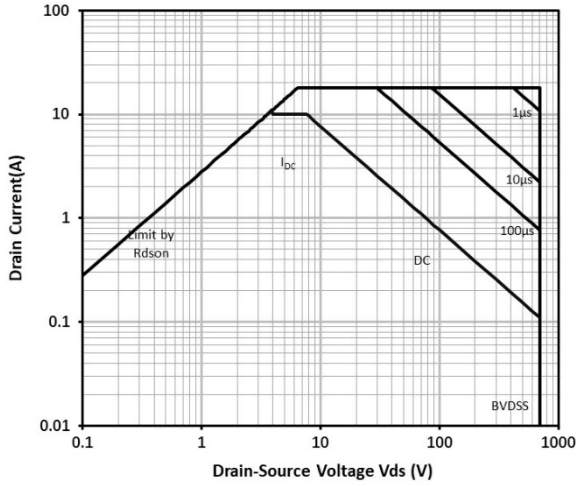

$I_D = f(V_{DS}); T_C = 25\text{ }^\circ\text{C}$

Figure 17 Safe operating area

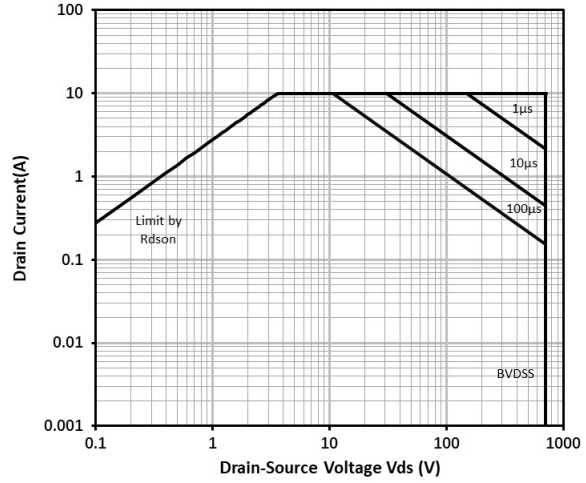

$I_D = f(V_{DS}); T_C = 125\text{ }^\circ\text{C}$

Figure 18 Typ. gate charge

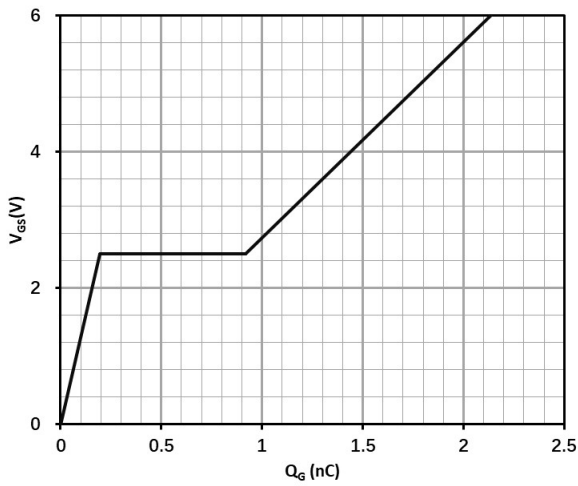

$V_{GS} = f(Q_G); V_{DCLINK} = 400\text{ V}; I_D = 3\text{ A}$

Figure 19 Typ. capacitances

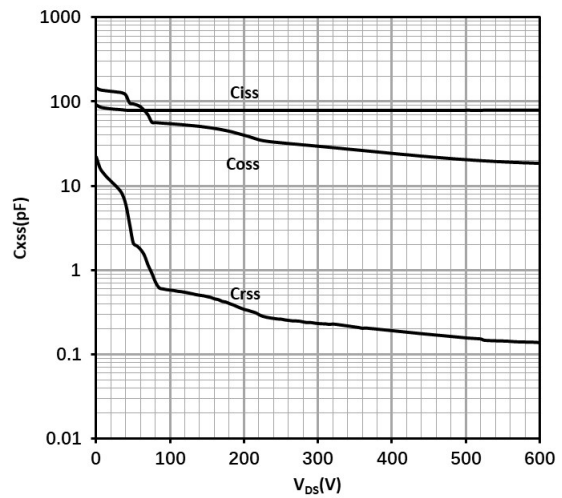

$C_{XSS} = f(V_{DS}); \text{Freq.} = 100\text{ kHz}$

Figure 20 Typ. output charge

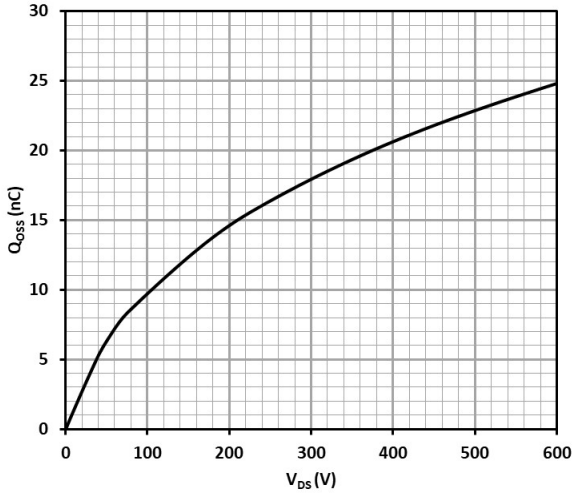

$Q_{oss} = f(V_{DS}); \text{Freq.} = 100 \text{ kHz}$

Figure 21 Typ. Coss stored Energy

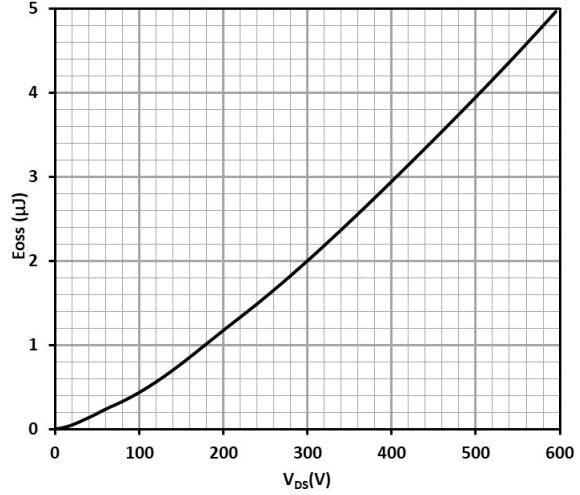

$E_{oss} = f(V_{DS}); \text{Freq.} = 100 \text{ kHz}$

Figure 22 Typ. Switching times with inductive load

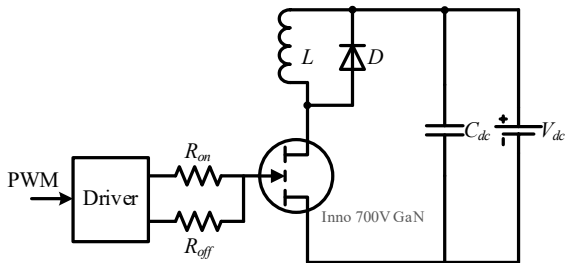

$V_{DS} = 400 \text{ V}, I_D = 6 \text{ A}, L = 318 \mu\text{H}, V_{GS} = 6 \text{ V},$
 $R_{on} = 10 \Omega, R_{off} = 2 \Omega$

Figure 23 Typ. Switching times waveform

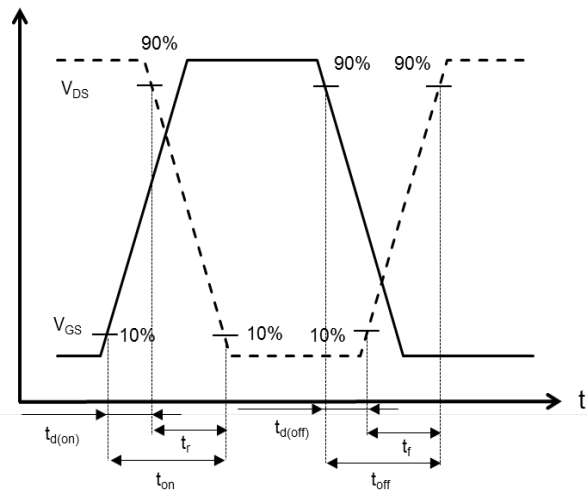

10. Package outlines

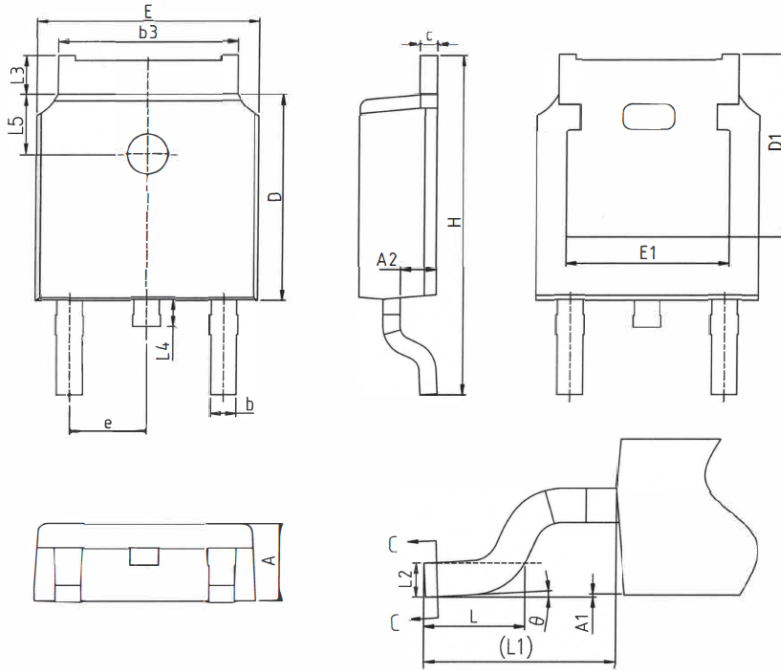

SYMBOL	MM			SYMBOL	MM		
	MIN	NOM	MAX		MIN	NOM	MAX
A	2.20	2.30	2.40	e	2.286BSC		
A1	0.00	-	0.13	H	9.40	10.10	10.50
A2	0.92	1.07	1.17	L	1.38	1.50	1.75
b	0.63	0.78	0.90	L1	2.90REF		
b3	5.10	5.33	5.46	L2	0.51BSC		
c	0.43	0.53	0.61	L3	0.88	-	1.28
D	5.98	6.10	6.22	L4	0.50	-	1.00
D1	5.30REF			L5	1.65	1.80	1.95
E	6.40	6.60	6.73	θ	0°	-	8°
E1	4.83REF						

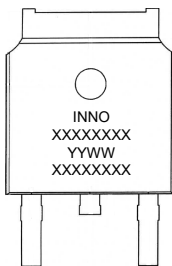

ROW	Description	Example
Row1	Company name	INNO
Row2	Product code	XXXXXXXX
Row3	Date code	YYYY
Row4	ASSY lot No.	XXXXXXXX

Notes:

- (1) All dimension are in millimeters.
- (2) Drawing is not to scale.
- (3) Dimensions do not include mold protrusion.
- (4) Package outline exclusive of metal burr dimensions.

11. Reel information

D	16.0	0.30	8.00	7.00	10.50	2.70	0.00	1.75	7.50	4.00	2.00	1.55	1.50	3.0	1.2	2.0	2.7	2.5	1.7	0.6
A	+0.40	+0.08	+0.15	+0.20	+0.15	+0.15	+0.00	+0.15	+0.15	+0.15	+0.15	+0.15	+0.25	+0.15	+0.15	+0.15	+0.15	+0.15	+0.15	+0.15
T	-0.20	-0.08	-0.15	-0.20	-0.15	-0.15	-0.10	-0.15	-0.15	-0.15	-0.15	-0.15	-0.25	-0.15	-0.15	-0.15	-0.15	-0.15	-0.15	-0.15
A	W	T	P	A0	B0	K0	K1	E	F	P0	P2	D0	D1	W1	W2	W3	H1	H2	H3	W4

Unit:mm

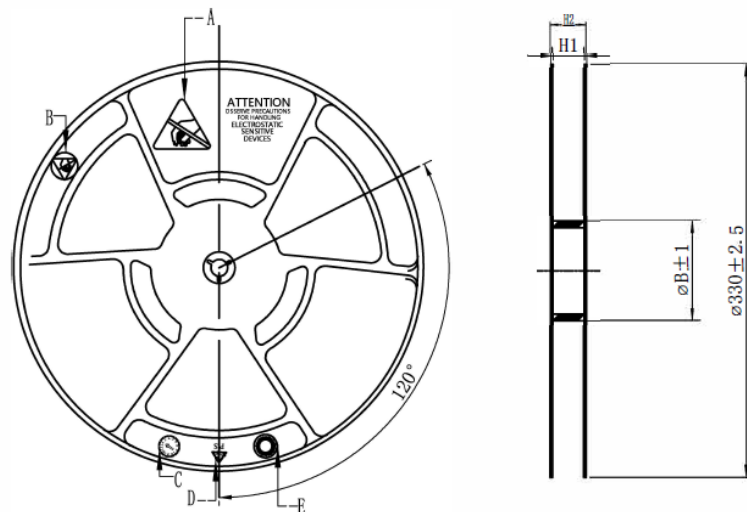
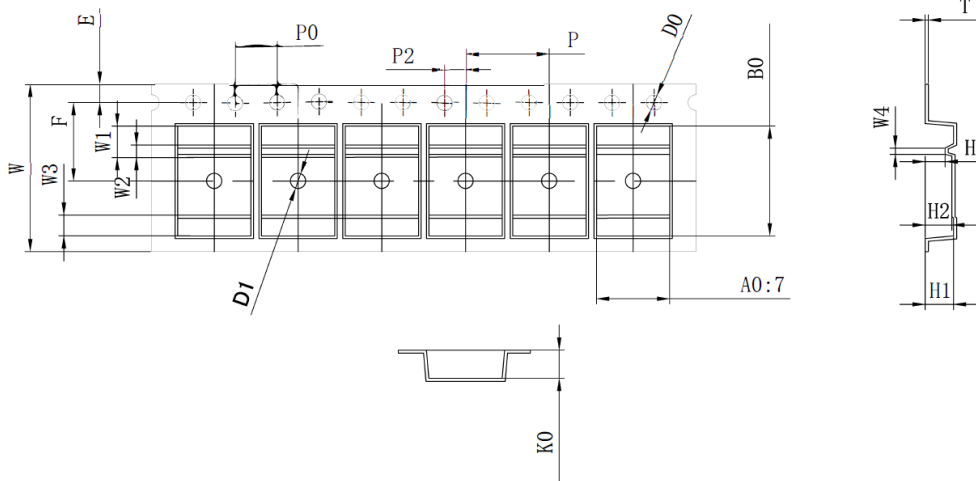

Unit:	mm
Tape Width	16
H1	16.4±0.1
H2MAX	22.4

12. Recommended PCB footprint

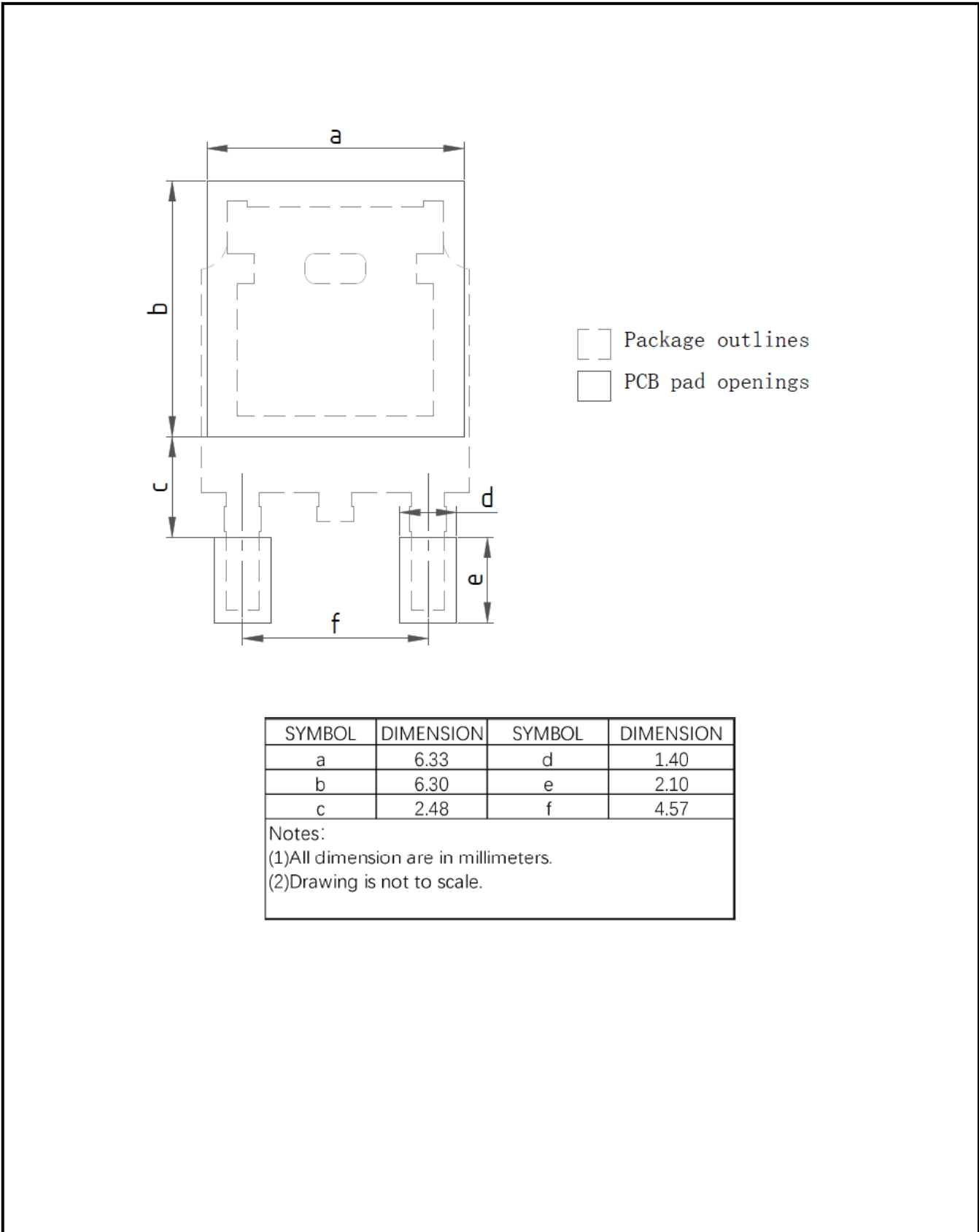

13. Revision history

Major changes since the last revision

Revision	Date	Description of changes
1.0	2023-07-20	1.0 version release
1.1	2023-12-26	1) Update Typ. channel reverse characteristics: add $V_{gs}=-6/-4V$ (Figure 5 & Figure 6) 2) Add Reel information

Important Notice

The information provided in this document is intended as a guide only and shall not in any event be regarded as a guarantee of conditions, characteristics or performance. Innoscience does not assume any liability arising out of the application or use of any product described herein, including but not limited to any personal injury, death, or property or environmental damage. No licenses, patent rights, or any other intellectual property rights is granted or conveyed. Innoscience reserves the right to modify without notice. All rights reserved.